

## DUPLEX SOLAR CONTROL UNIT



### Product description

Duplex solar control unit for mid-sized to complex solar and heating systems, fitted with outputs and inputs for heat quantity meters (volume measuring instrument or VFS sensor required), web-connected (module required), actuation of high-efficiency pumps and MicroSD card slot and LAN and mini-USB connection. 27 pre-configured systems available. Numerous functions such as drainback, booster, timer, bypass, external WT, twin pump, thermal disinfection, zone charging and blocking protection can be connected, freely-programmable function blocks. 2 additional micro buttons for fast access to manual mode and holiday function. Integrated multi-coloured control LED for differentiated message-display of various system conditions. Automatic function check as per VDI guideline 2169.

- 4 relay outputs (incl. 1 floating low-voltage relay)
- 4 inputs for temperature sensors Pt1000, Pt500 or KTY
- 1 input for analogue Grundfos Direct Sensor™
- 1 pulse input for V40 (can be switched to temperature sensor input Pt1000, Pt500 or KTY)
- 2 pulse-duration modulation outputs for speed-controlled actuation of high-efficiency pumps
- Can be connected to the web (module required)
- MicroSD card slot, LAN and mini-USB connections
- 27 pre-configured basic systems selectable
- Automatic function check as per VDI 2169

### Specifications

Type	<b>Duplex</b>
Item no.	<b>1510659</b>
Inputs	4 temperature sensors Pt1000, Pt500 or KTY, 1 Grundfos Direct Sensor™ (analogue), 1 pulse input V40 (can be switched to temperature sensor input Pt1000, Pt500 or KTY)
Outputs	3 semiconductor relays, 1 floating low-voltage relay, 2 pulse-duration modulation outputs (can be switched to 0-10 V)
Pulse-duration modulation frequency	512 Hz
Pulse-duration modulation voltage	10.8 V
Switching capacity	1 (1) A 240 V~ (semiconductor relay) 1 (1) A 30 V= (floating relay)
Total switching power	4 A, 240 V
Supply	100 - 240 V~ (50 - 60 Hz)
Type of connection	Y
Power consumption	< 1 W (standby)
Working principle	Type 1.B.C.Y
Rated surge voltage	2.5 kV
Data interface	VBus®, MicroSD card slot, LAN interface, mini-USB interface
VBus® current output	60 mA
Functions	ΔT control, running time meter, tube collector function, thermostat function, speed control, heat quantity metering, stratified charging of tank, priority logics, drainback option, booster function, heat dump, thermal disinfection, pulse-duration modulation pump actuation, adjustable system parameters, balancing and diagnostic functions, function control in accordance with VDI 2169
Housing	Plastic, PC-ABS and PMMA
Installation	Wall installation, control panel installation possible
Display	Full-graphics display, control light (Lightwheel®) and backlight
Operation	4 pushbuttons and 1 thumb wheel (Lightwheel®)
Protection class	IP 20 / DIN EN 60529
Protection class	I
Ambient temperature	0 ... 40 °C
Degree of contamination	2
Dimensions	110 x 166 x 47 mm

# SOLAR CONTROL UNITS



## DUPLEX SOLAR CONTROL UNIT

### Housing dimensions and installation:

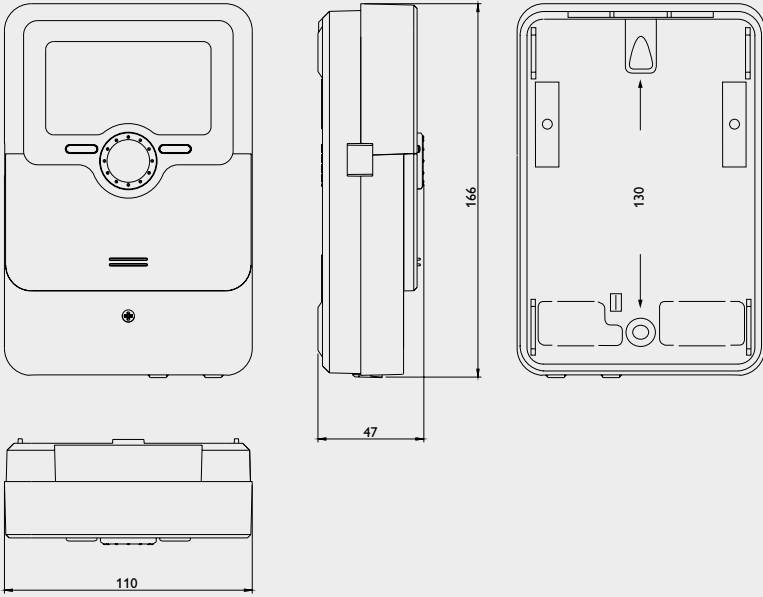

### Electrical connection:

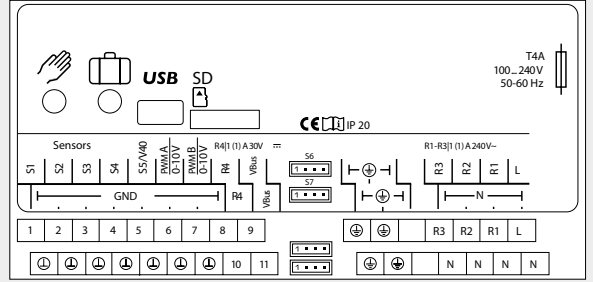

### Example applications:

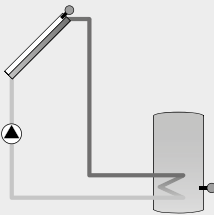

Example 01:  
Solar system with 1 tank

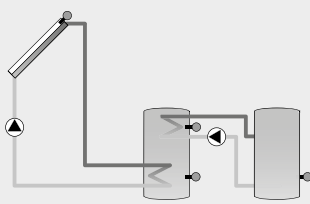

Example 02:  
Solar system with 2 tanks and heat transfer

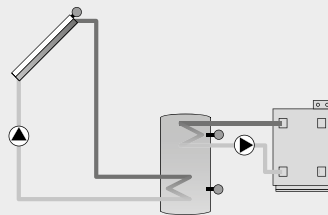

Example 03:  
Solar system with 1 tank and secondary heat source

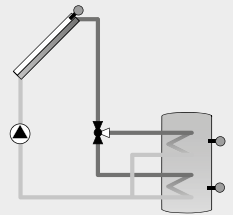

Example 04:  
Solar system with 1 tank and 3-way valve for stratified charging of tank

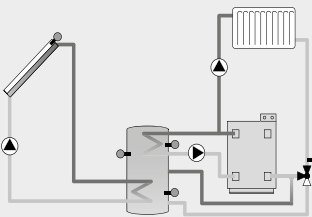

Example 05:  
Solar system with 1 tank, return flow increase and secondary heat source

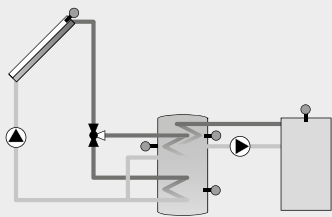

Example 06:  
Solar system with stratified tank and solid fuel boiler

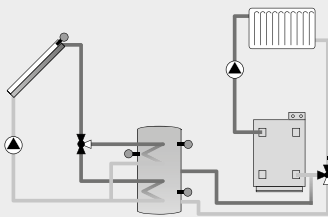

Example 07:  
Solar system with stratified tank and solid fuel boiler and return flow increase

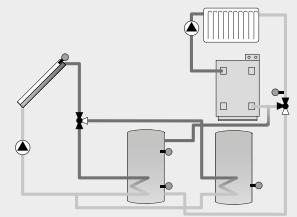

Example 08:  
Solar system with 2 tanks, valve logics and return flow increase